

# Fifty shades of Blech.

metal solutions

**hoedtke**  
—

# Inhalt

**Blechbearbeitung 05**  
**Schweißfachbetrieb 13**  
**Zerspanung 19**  
**Werkzeugbau 25**  
**3D-Druck 29**  
**Messen und Prüfen 33**  
**Vakuumtechnik 37**  
**Baugruppen und Systeme 45**  
**Luftfahrt 53**  
**Engineering 57**  
**Lackierungen und  
Pulverbeschichtungen 63**

metal solutions

**hoedtke**



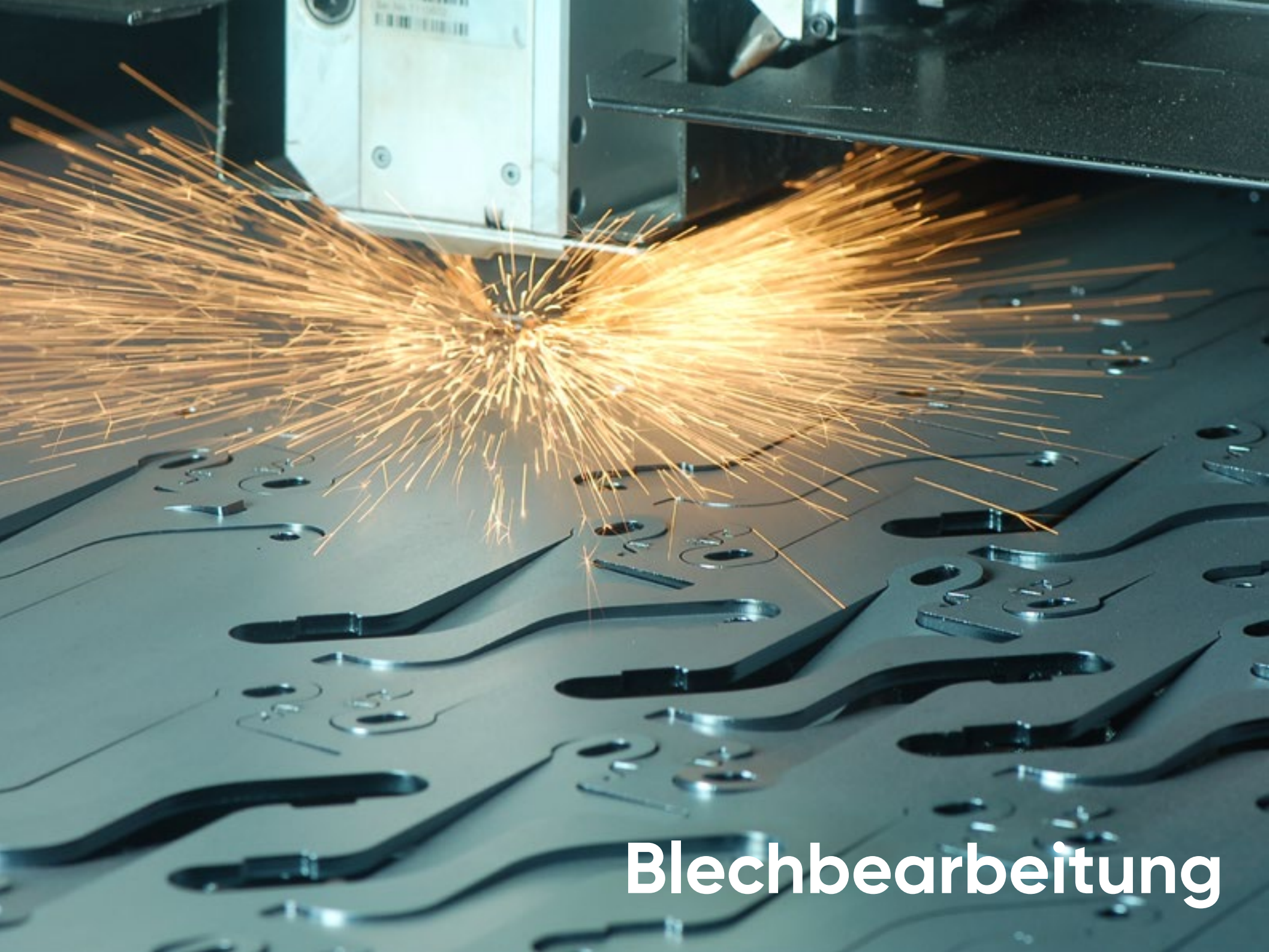

**Blechbearbeitung**

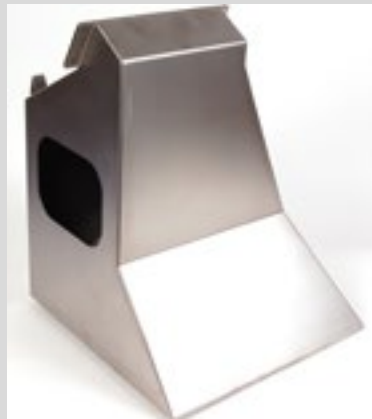
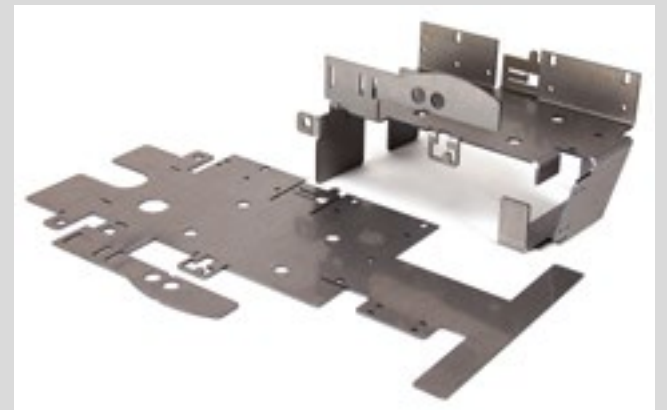

# Blechbearbeitung

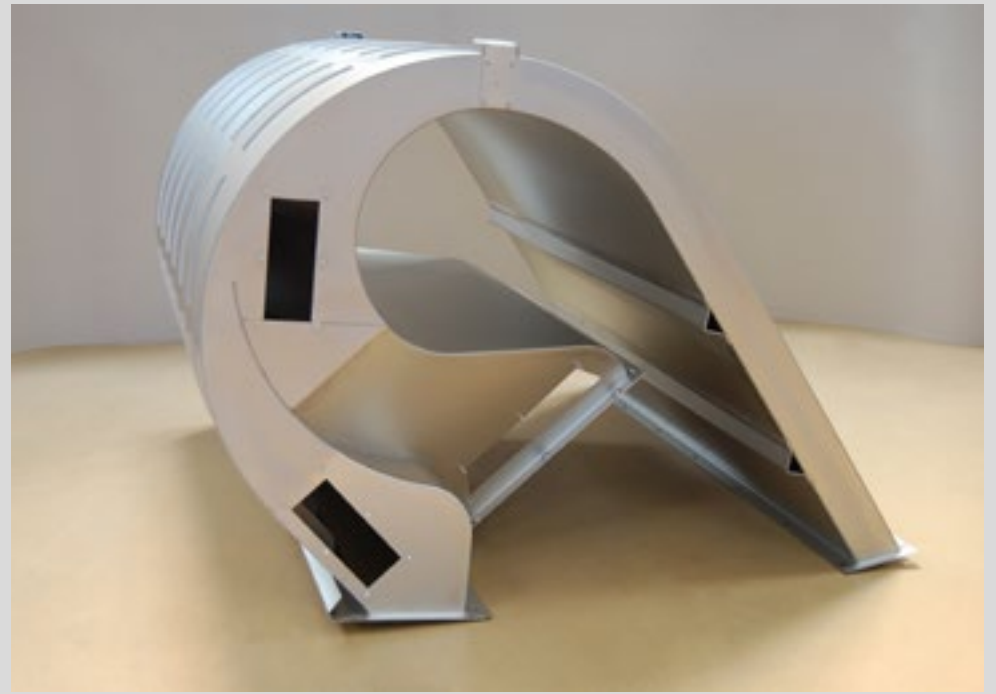
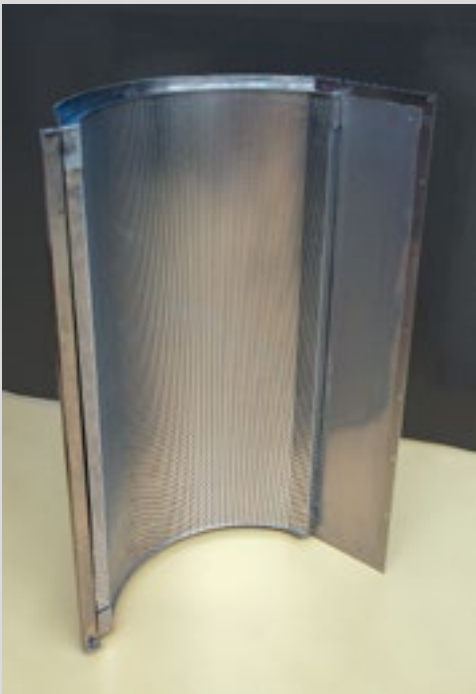

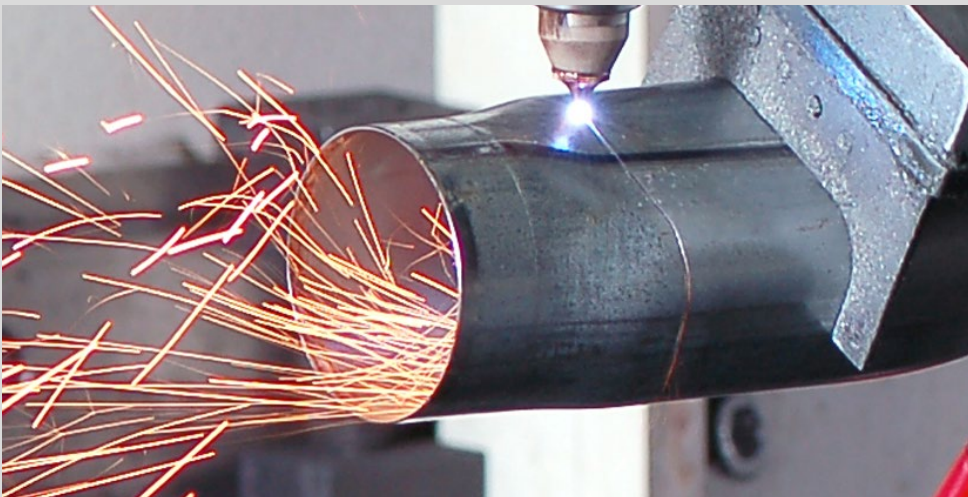
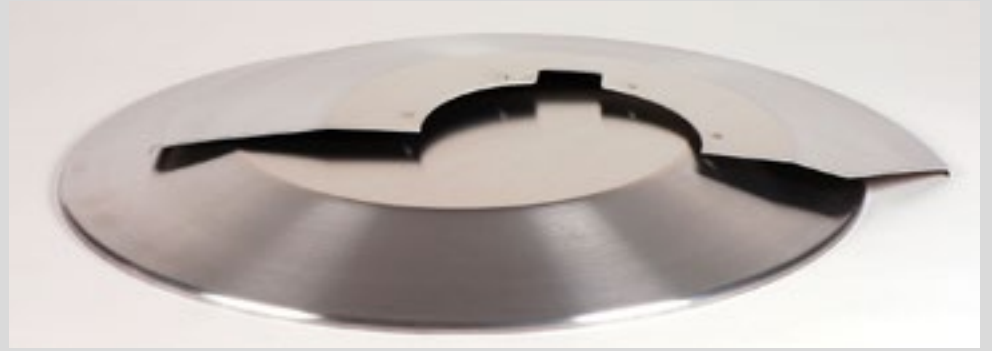
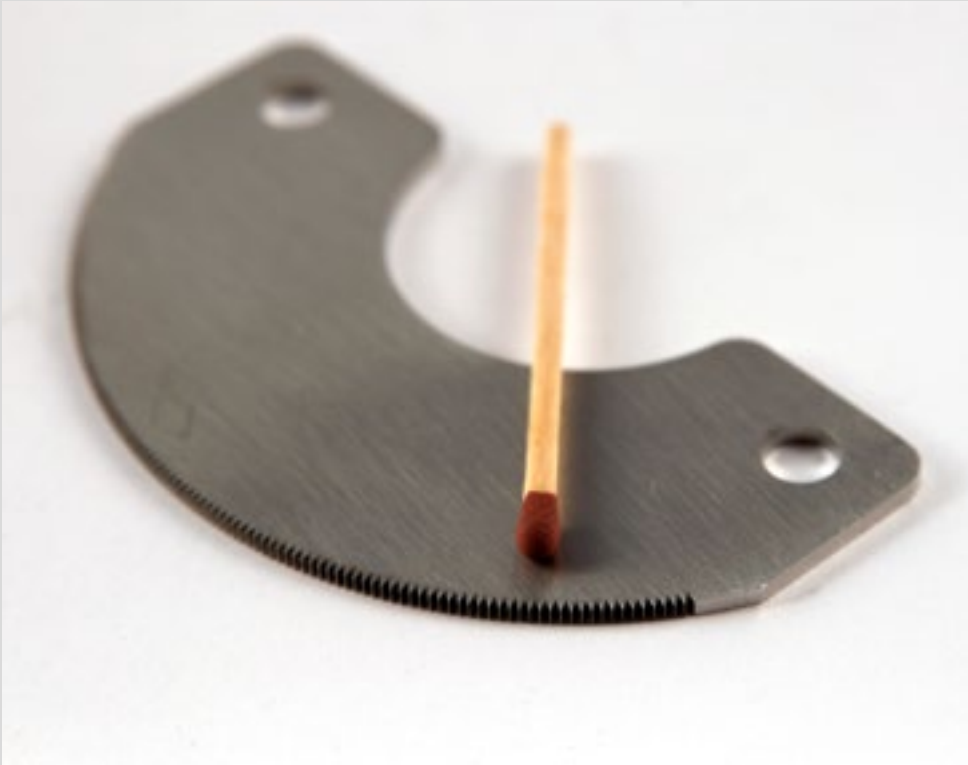

# Blechbearbeitung





# Blechbearbeitung







**Schweißfachbetrieb**

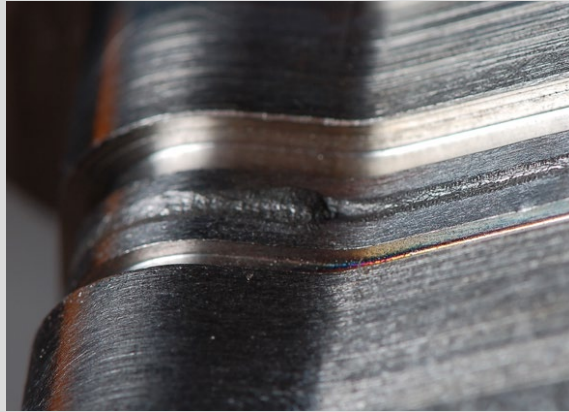

# Schweißfachbetrieb





# Schweißfachbetrieb

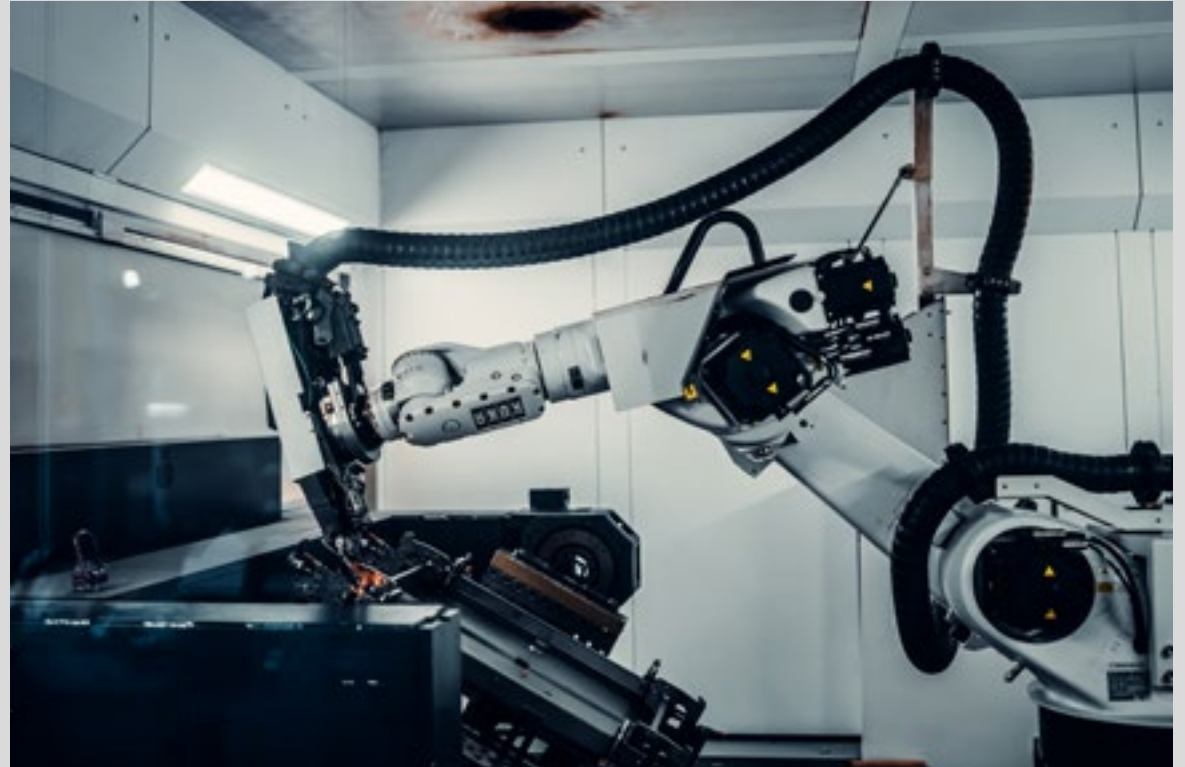



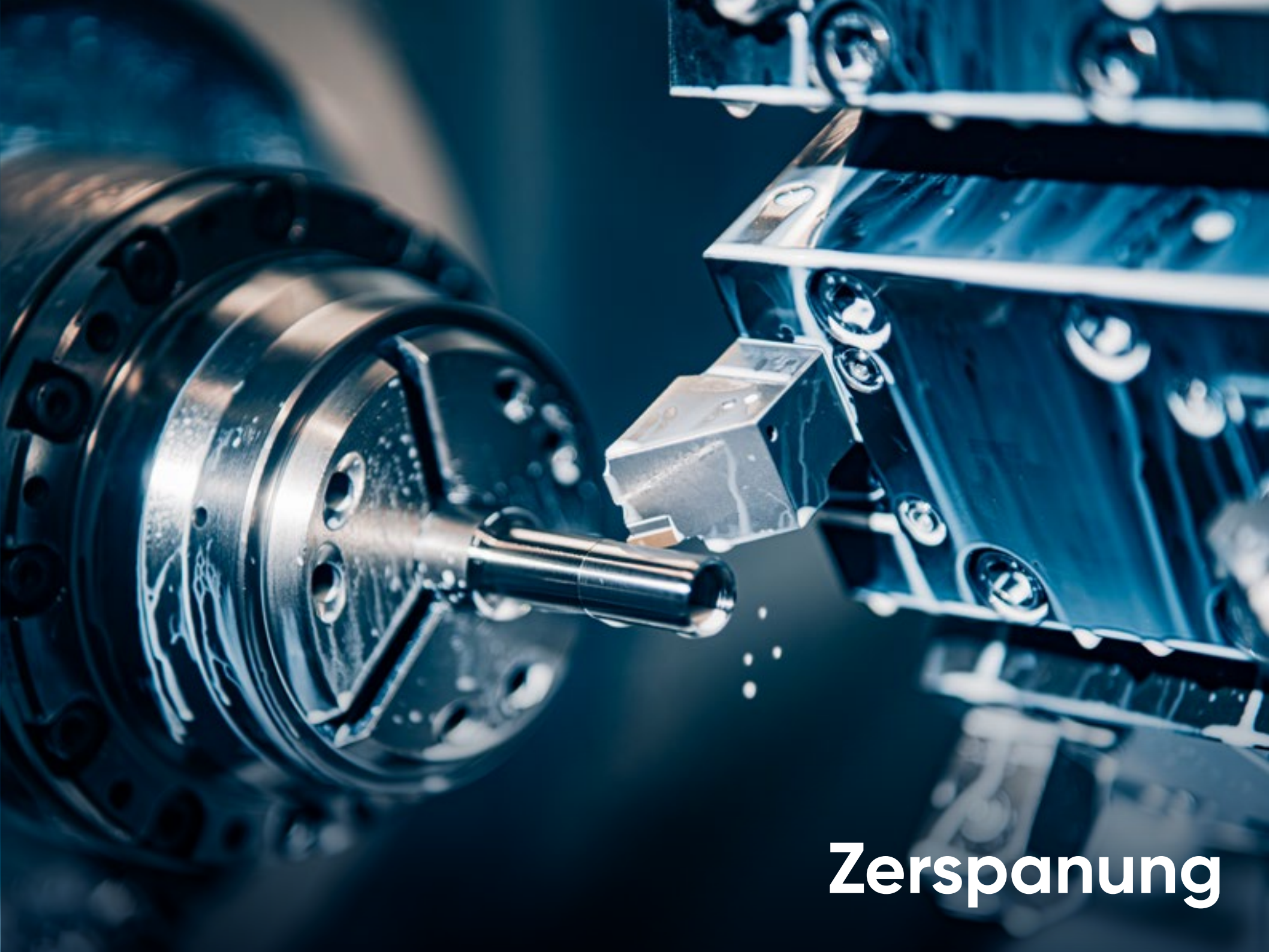

**Zerspanung**

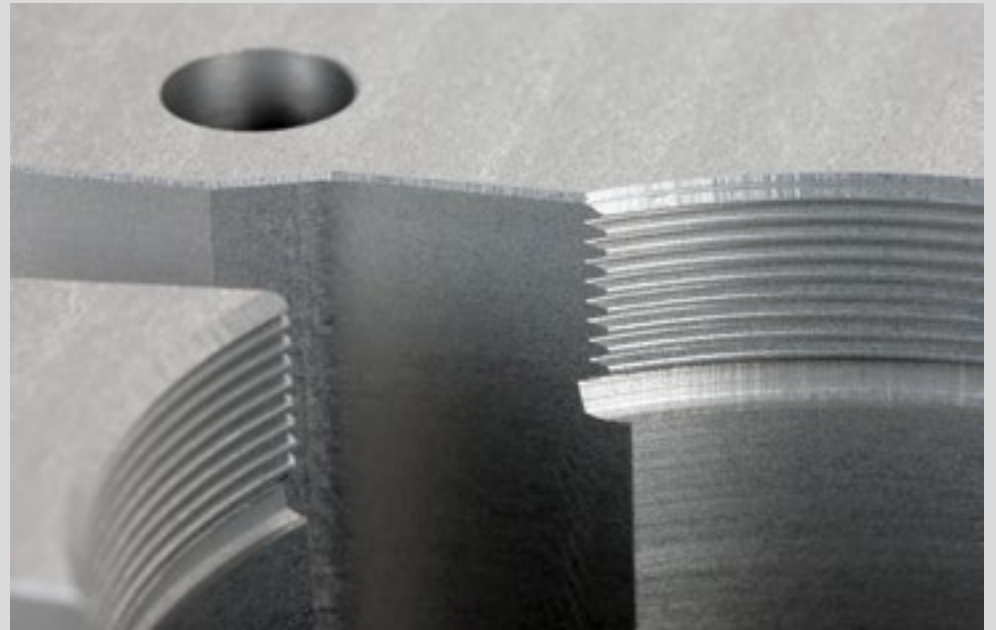



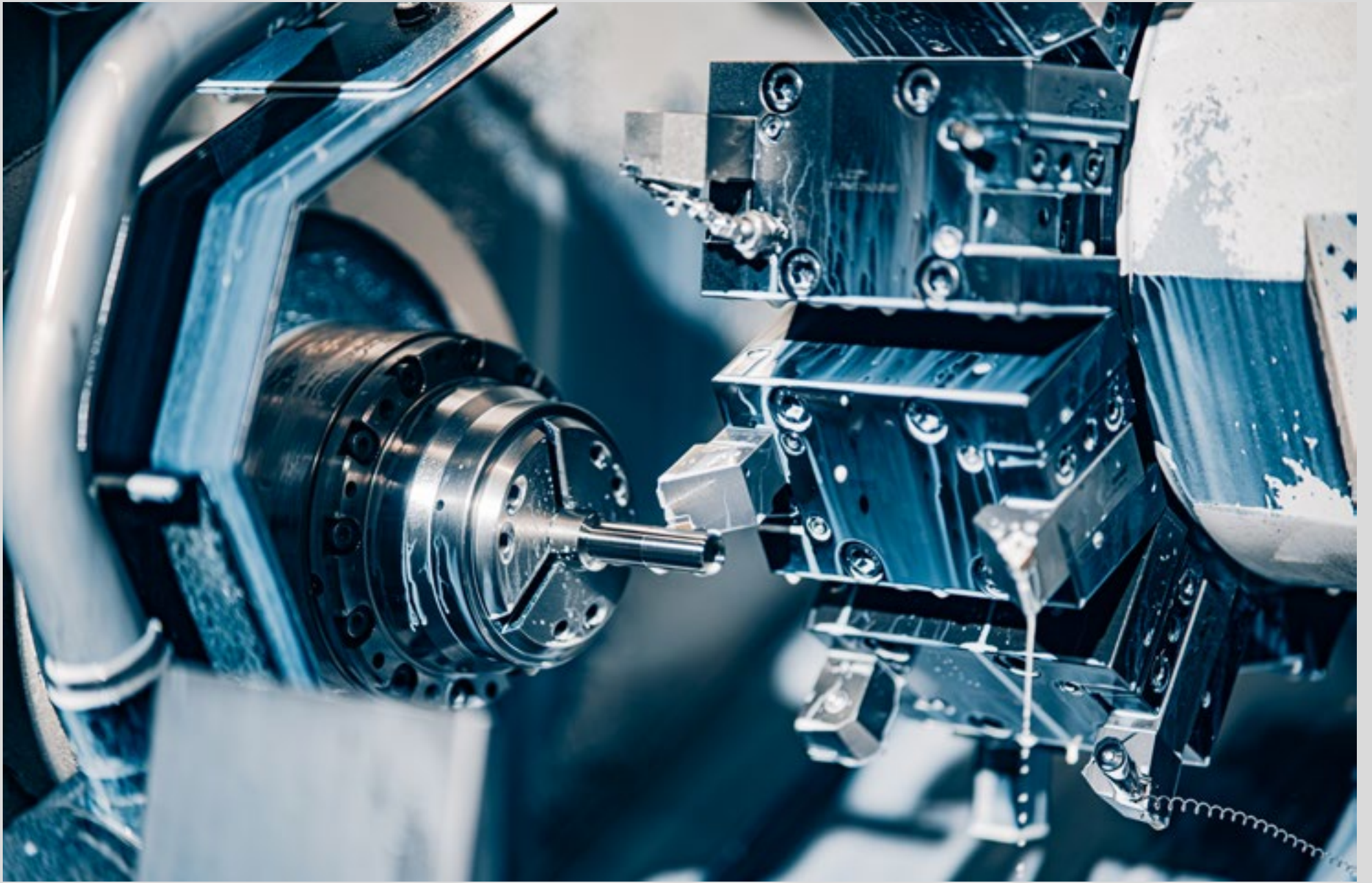

# Zerspanung

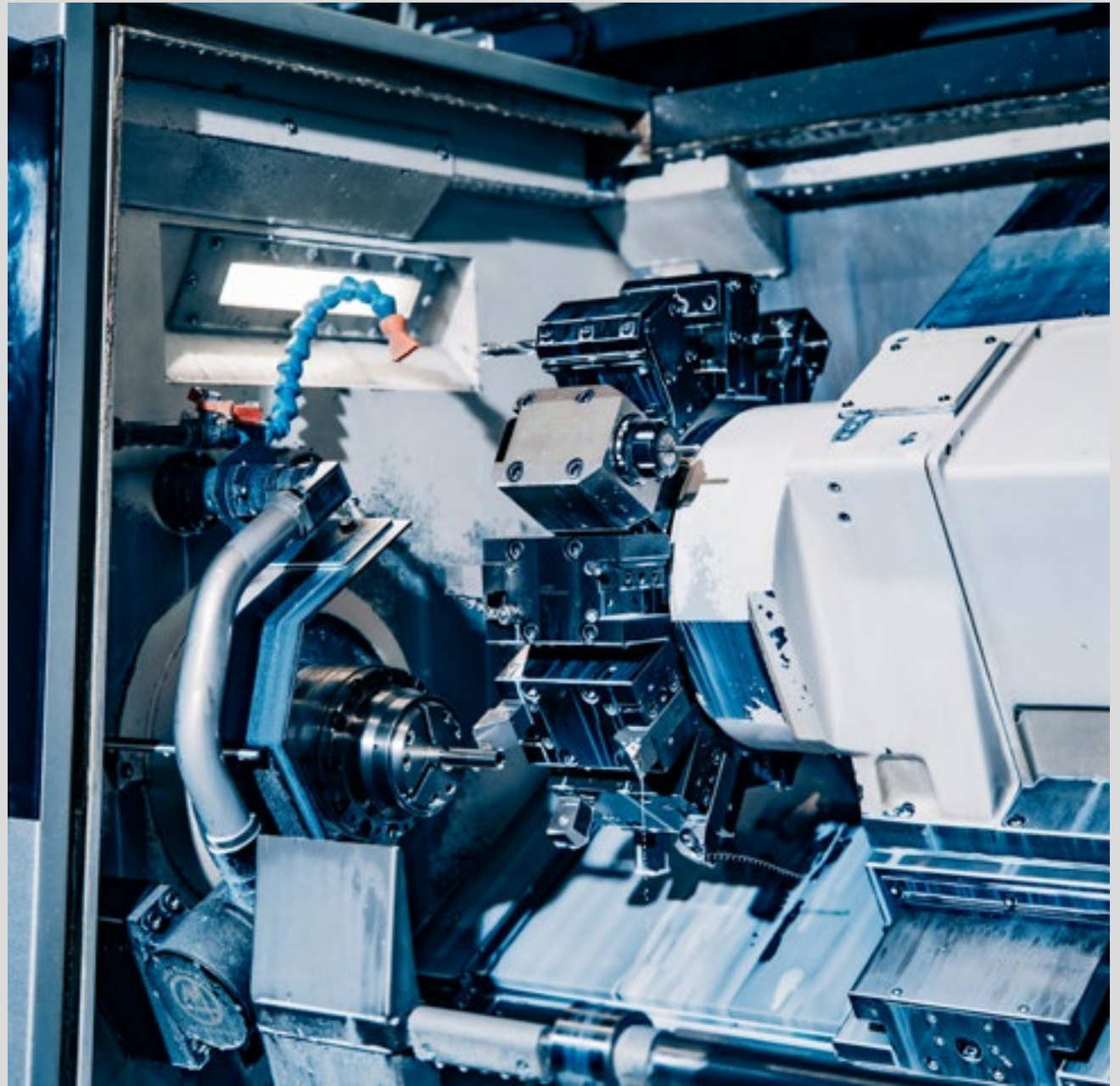





**Werkzeugbau**

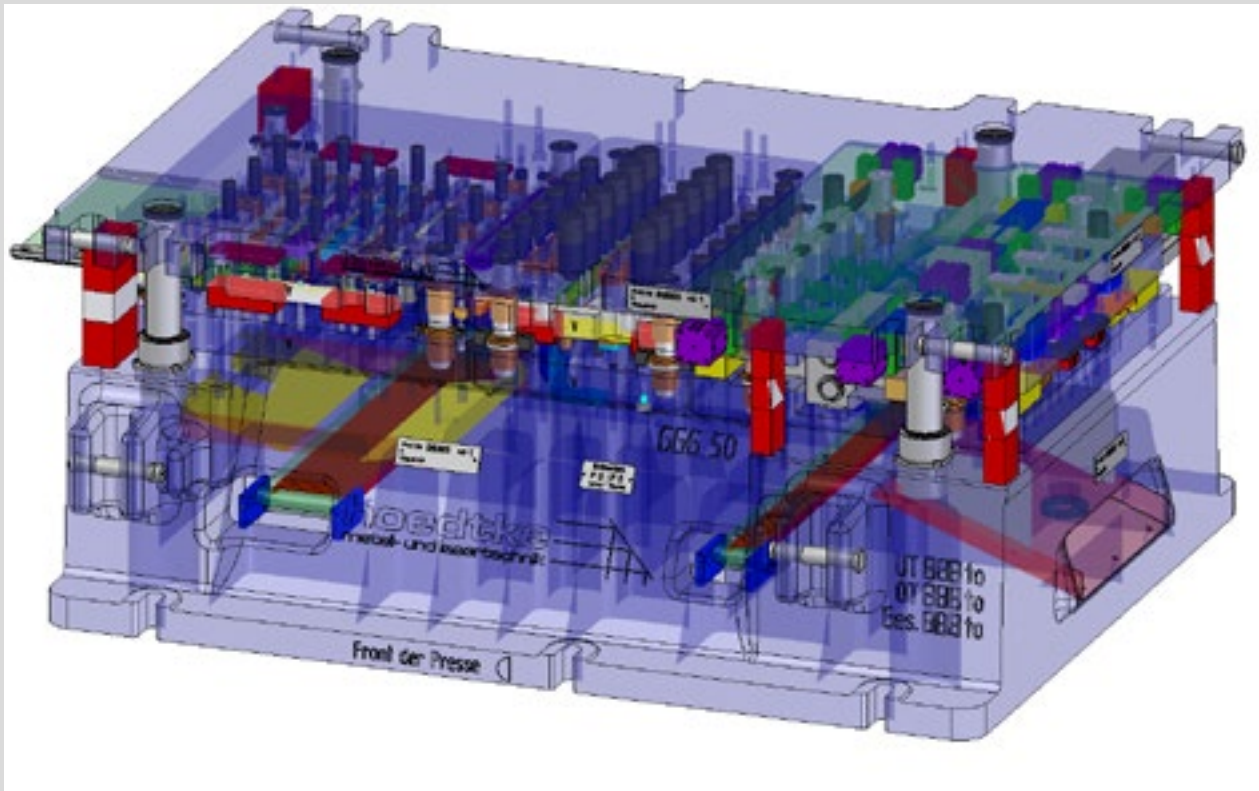







**3D-Druck**









**Messen und Prüfen**

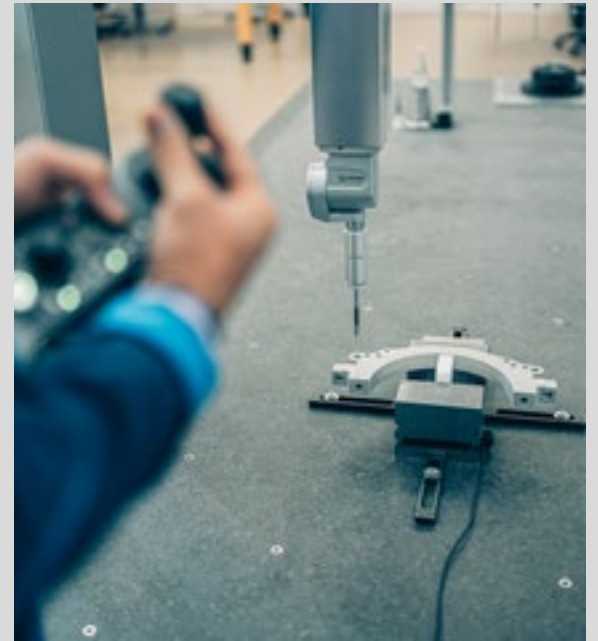

# Messen und Prüfen

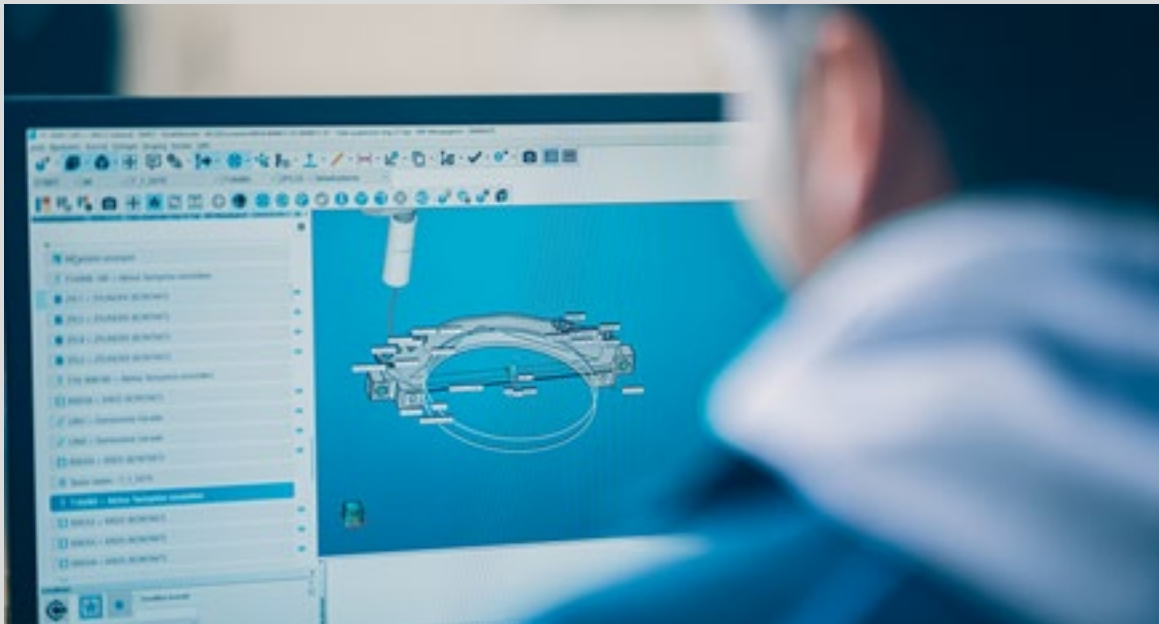





secundo

Vakuumtechnik

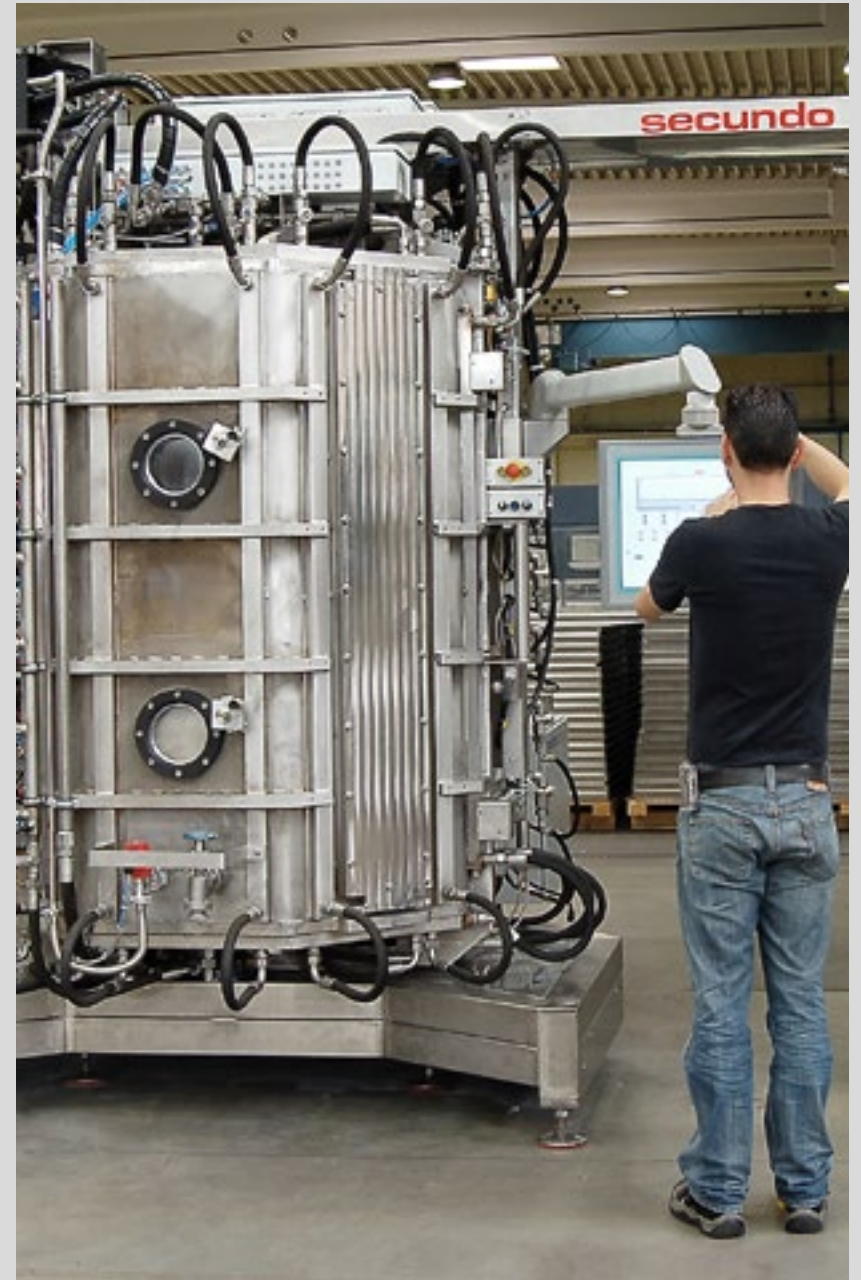

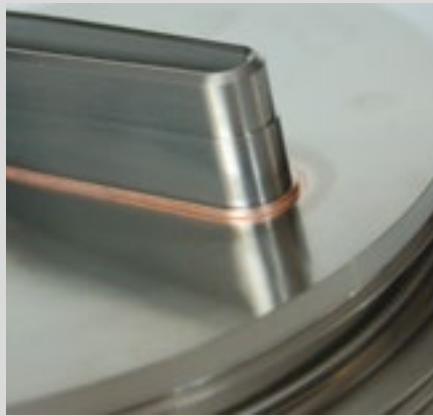







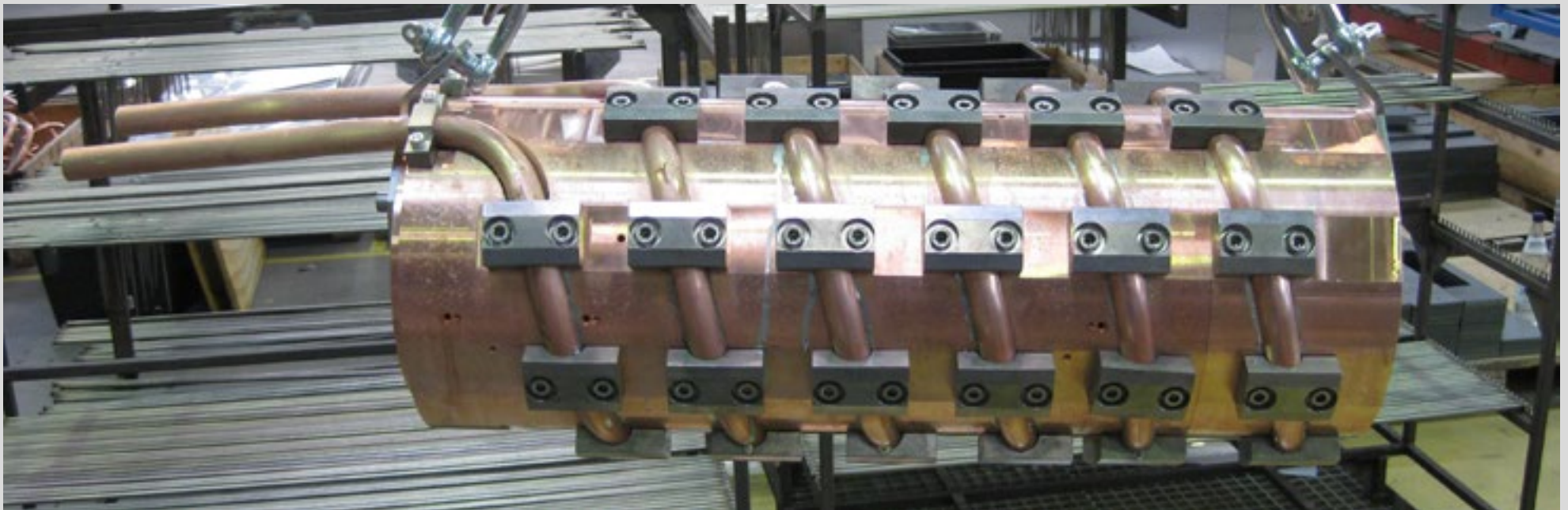
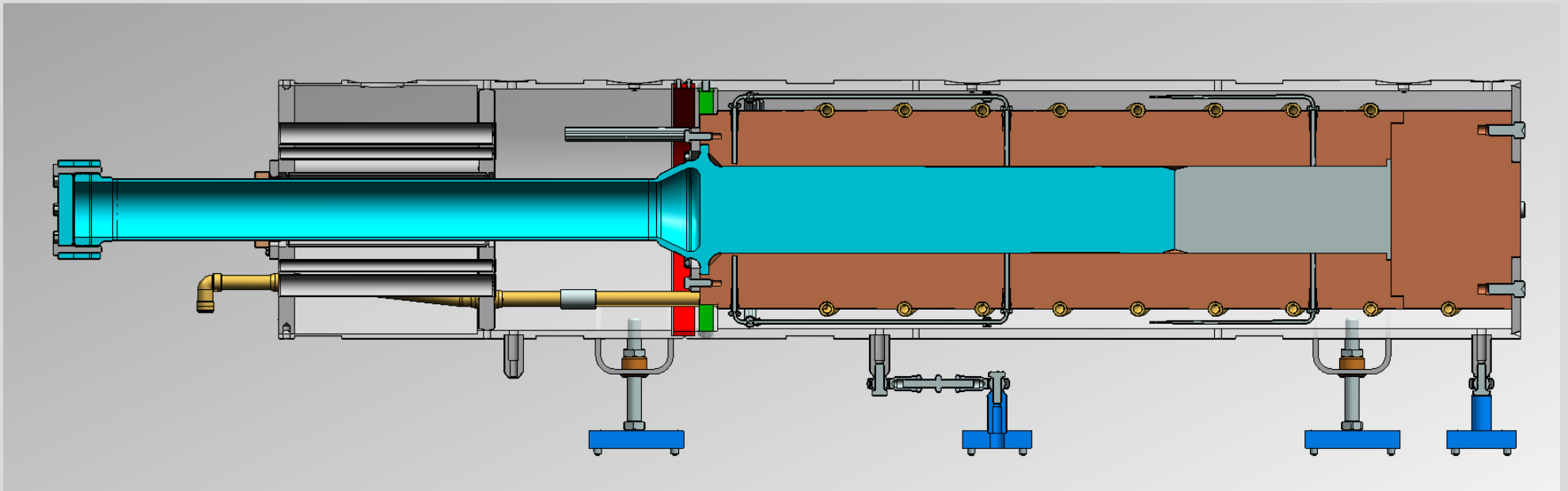





# Baugruppen und Systeme

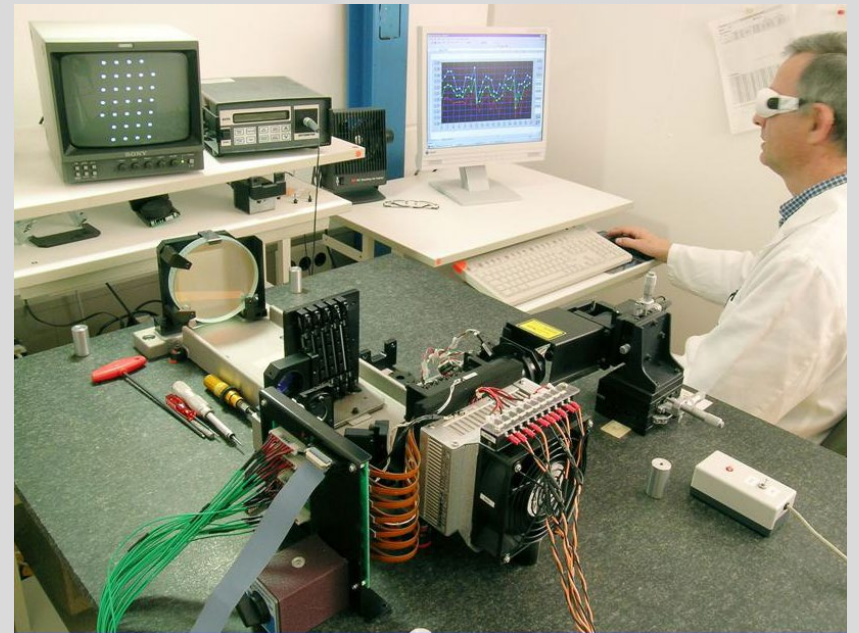

# Baugruppen und Systeme

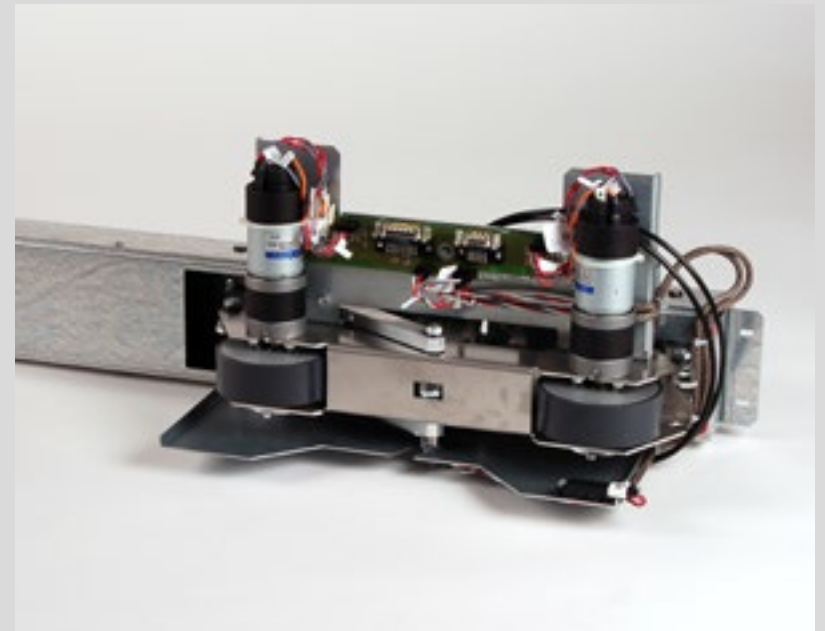



# Baugruppen und Systeme



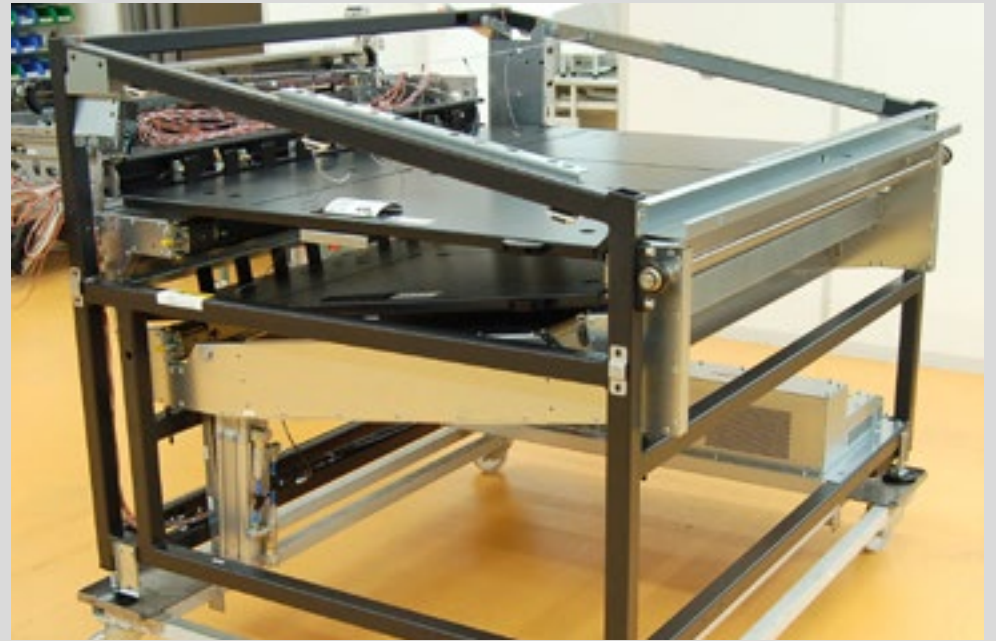

# Baugruppen und Systeme







Luftfahrt



# Baugruppen und Systeme

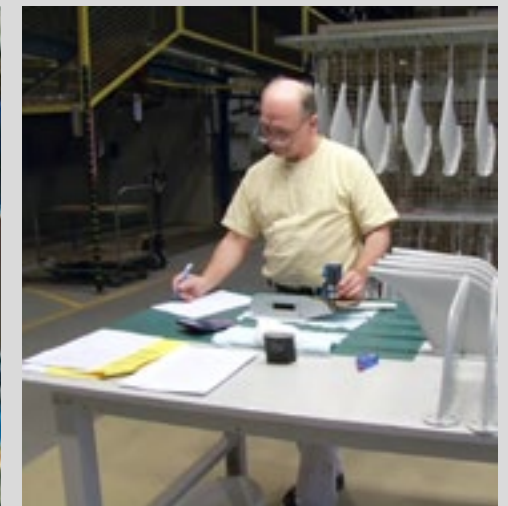
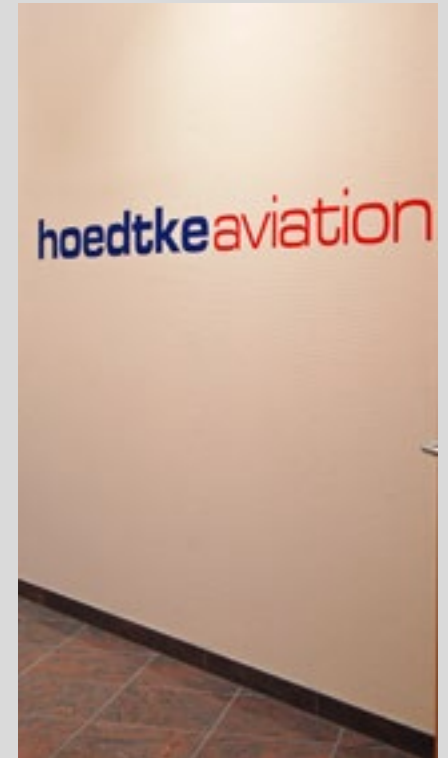
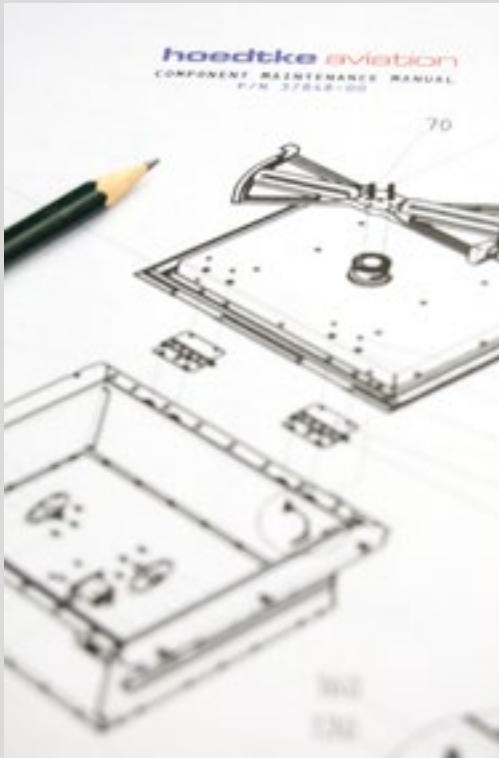



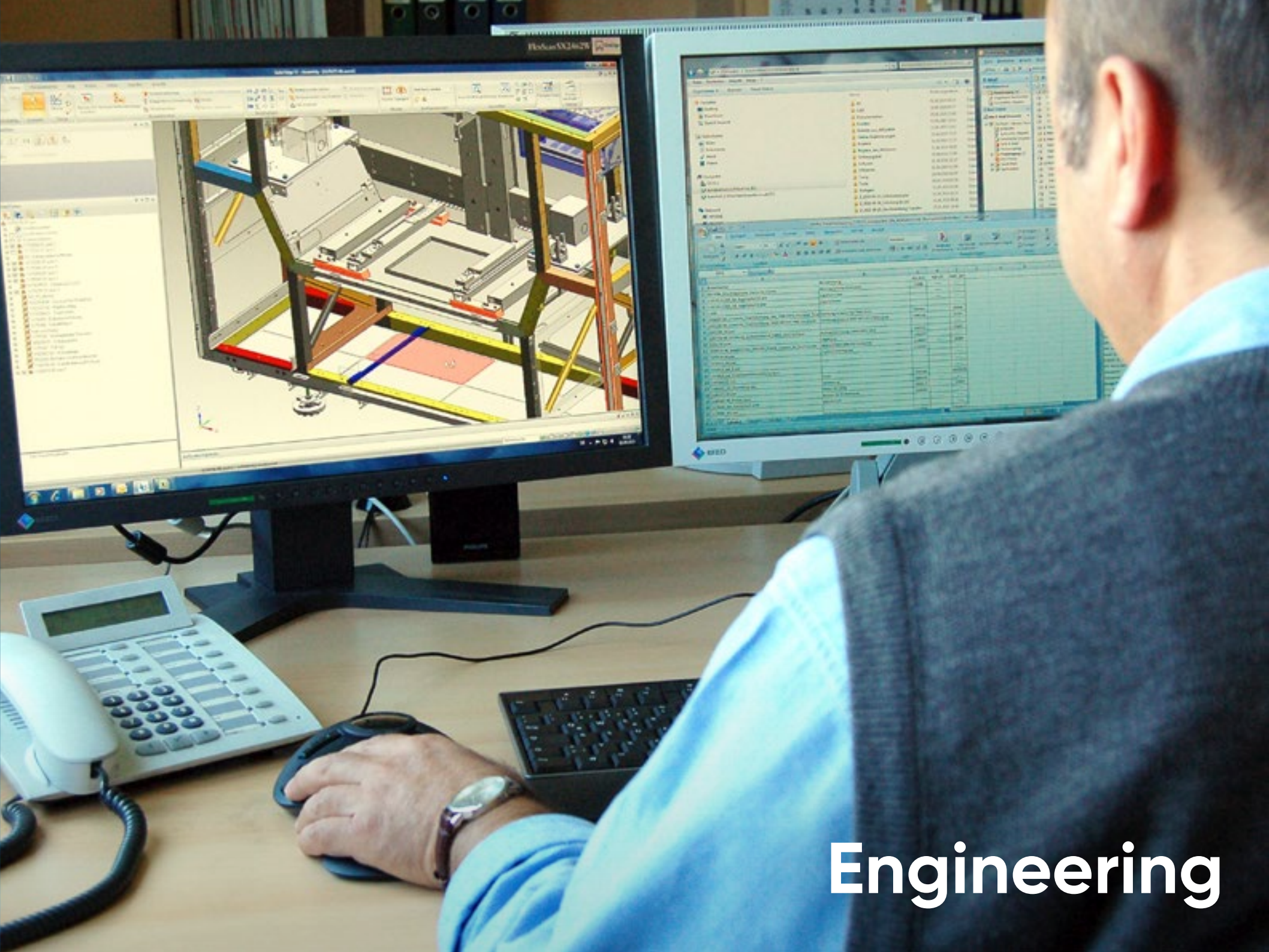

**Engineering**

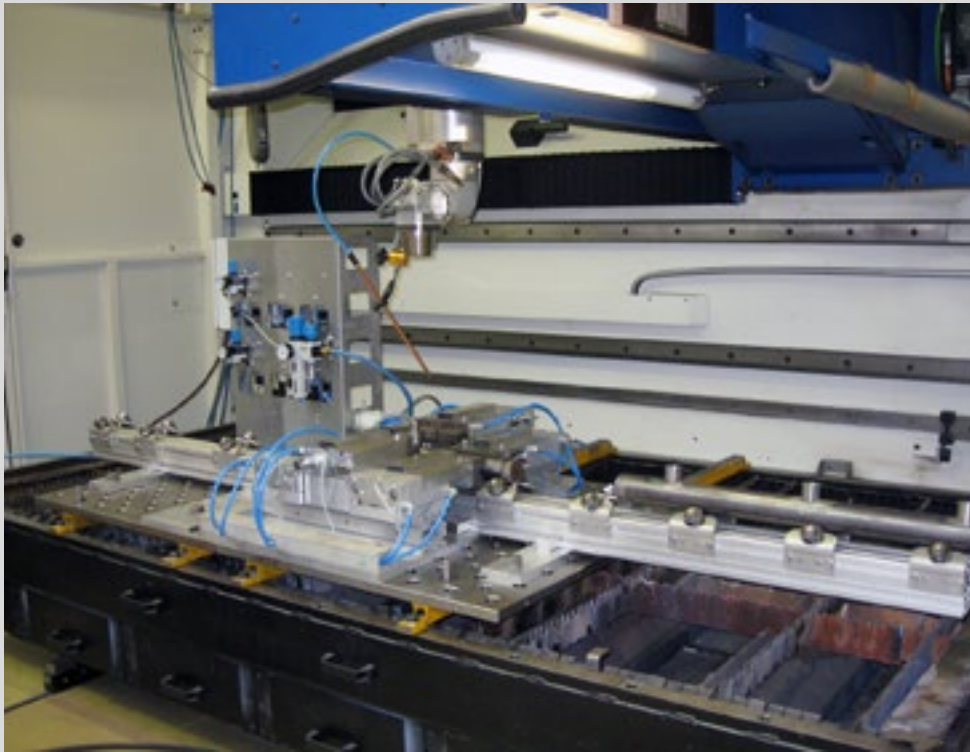
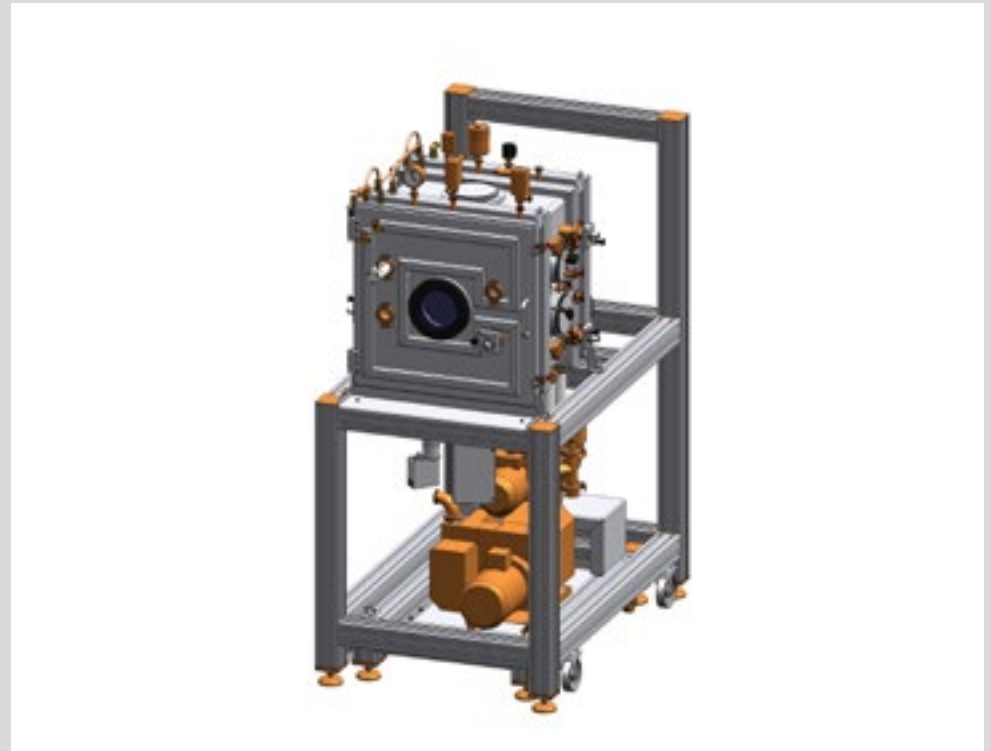
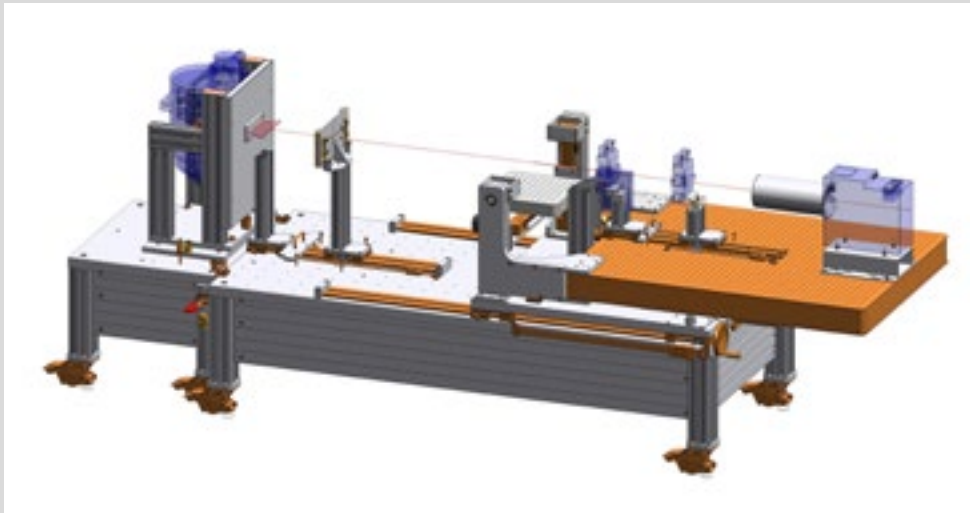

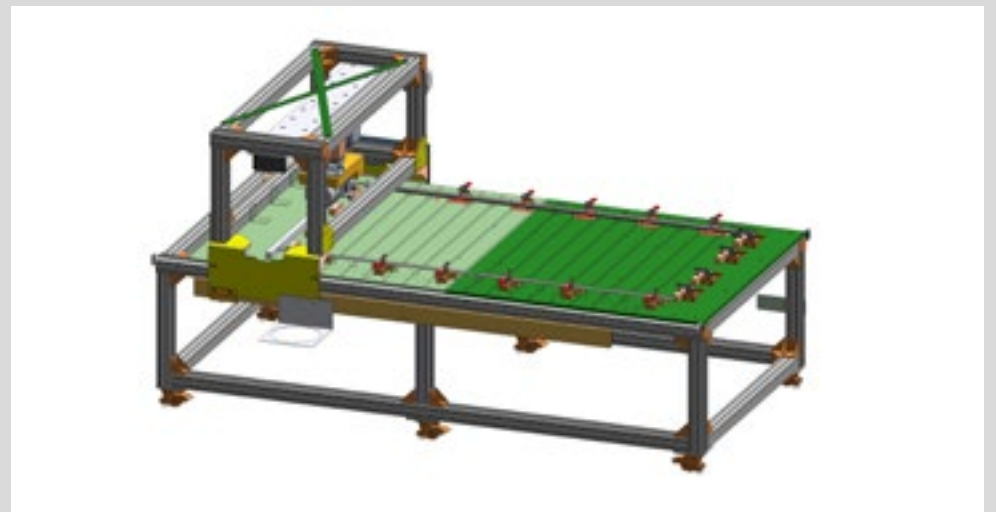
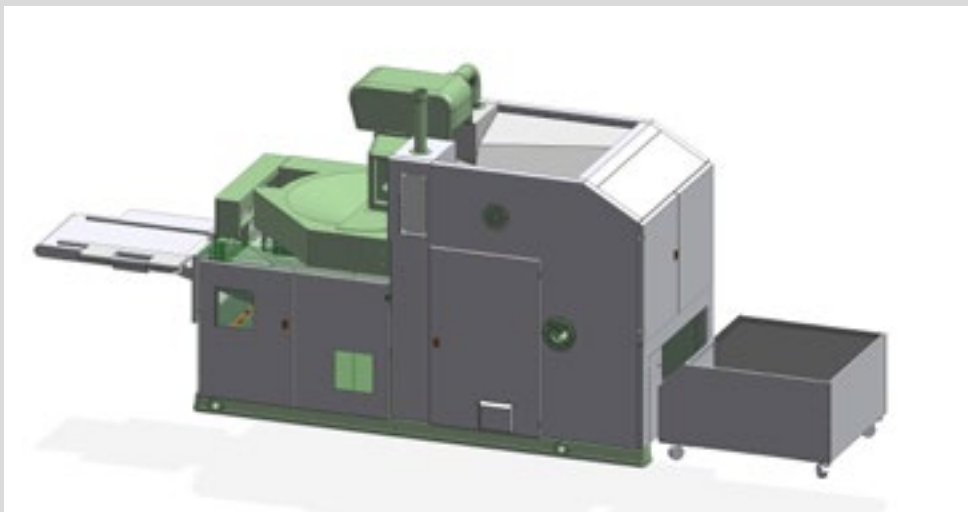

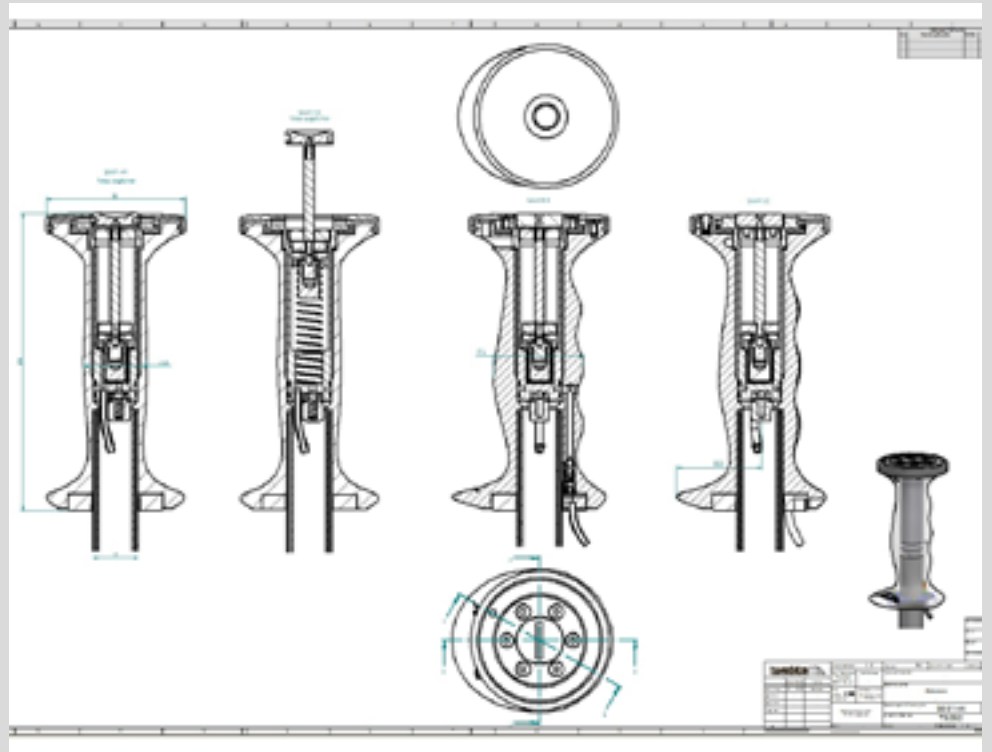
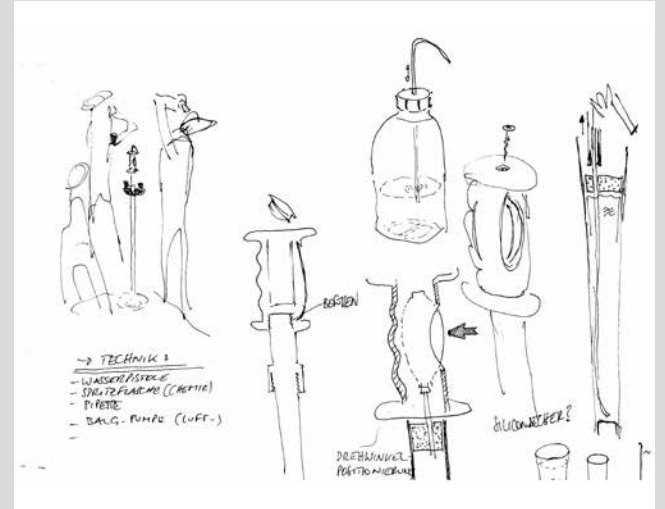
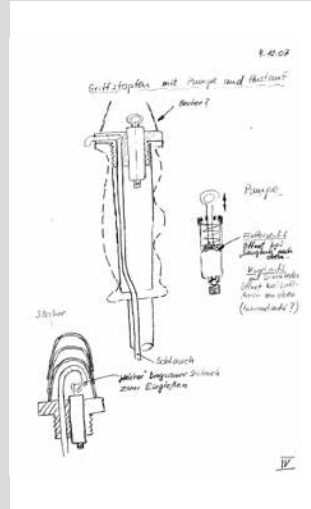
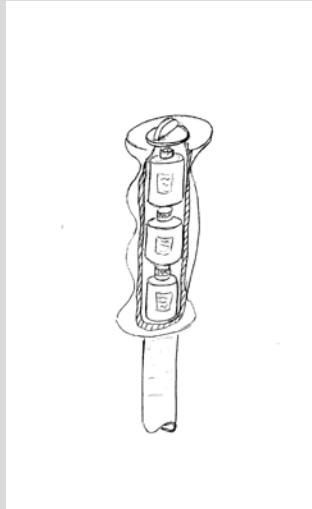
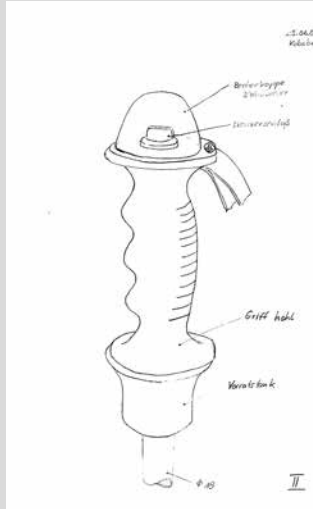
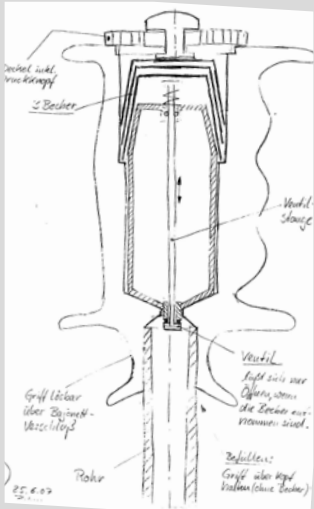

# Engineering

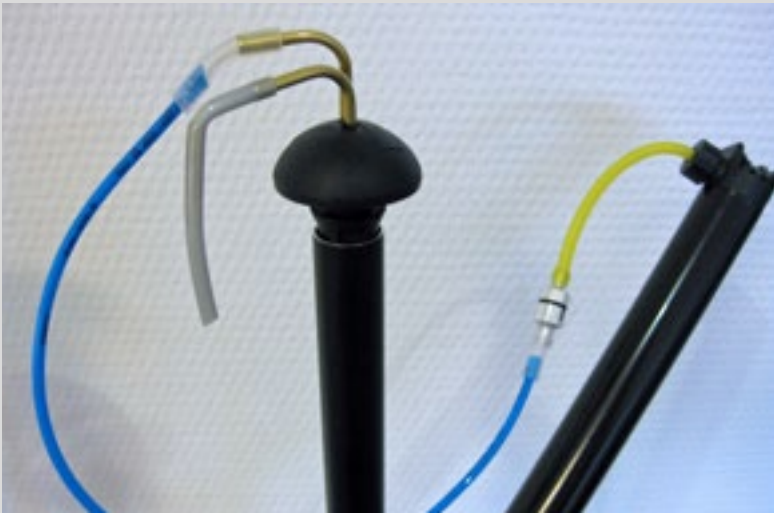





**Lackierungen und  
Pulverbeschichtungen**



# Lackierungen und Pulverbeschichtungen





**Hoedtke GmbH & Co. KG**  
metal solutions  
Industriestraße 2-6  
D-25421 Pinneberg  
Telefon: 04101 70 99-0

**Hoedtke Kiel GmbH & Co. KG**  
metal solutions  
Liebigstraße 12-14  
D-24145 Kiel  
Telefon: 0431 7 17 99-0

